

Břitové destičky GEN2 T-A®

Série 1 | Rozsah průměrů: 17,53 mm - 24,38 mm (0.690" - 0.960")

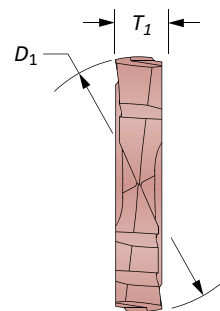
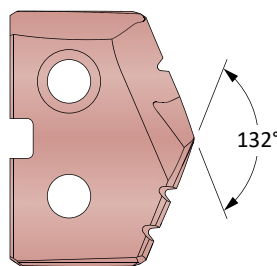

Destičky HSS – Super Cobalt • Karbidové destičky – K20 (C2) | K35 (C1)

Série	Destička			T ₁ mm	Kód destičky HSS			Kód karbidové destičky		
	D ₁ mm	D ₁ inch	Palců (zlomkem)		Super Cobalt	C2	C1			
1	17.86	0.7031	45/64	4.00	451H-.703	4C21H-.703	4C11H-.703			
	18.00	0.7087	–		451H-18	4C21H-18	4C11H-18			
	18.26	0.7188	23/32		451H-0023	4C21H-0023	4C11H-0023			
	18.50	0.7283	–		451H-18.5	4C21H-18.5	4C11H-18.5			
	18.65	0.7344	47/64		451H-.734	4C21H-.734	4C11H-.734			
	19.00	0.7480	–		451H-19	4C21H-19	4C11H-19			
	19.05	0.7500	3/4		451H-0024	4C21H-0024	4C11H-0024			
	19.45	0.7656	49/64		451H-.765	4C21H-.765	4C11H-.765			
	19.50	0.7677	–		451H-19.5	4C21H-19.5	4C11H-19.5			
	19.84	0.7813	25/32		451H-0025	4C21H-0025	4C11H-0025			
	20.00	0.7874	–		451H-20	4C21H-20	4C11H-20			
	20.24	0.7969	51/64		451H-.796	4C21H-.796	4C11H-.796			
	20.34	0.8010	–		451H-.801	4C21H-.801	4C11H-.801			
	20.50	0.8071	–		451H-20.5	4C21H-20.5	4C11H-20.5			
	20.64	0.8125	13/16		451H-0026	4C21H-0026	4C11H-0026			
	21.00	0.8268	–		451H-21	4C21H-21	4C11H-21			
	21.43	0.8438	27/32		451H-0027	4C21H-0027	4C11H-0027			
21.50	0.8465	–	451H-21.5	4C21H-21.5	4C11H-21.5					
1.5	21.83	0.8594	55/64	4.00	451H-.859	4C21H-.859	4C11H-.859			
	22.00	0.8661	–		451H-22	4C21H-22	4C11H-22			
	22.23	0.8750	7/8		451H-0028	4C21H-0028	4C11H-0028			
	22.50	0.8858	–		451H-22.5	4C21H-22.5	4C11H-22.5			
	20.62	0.8906	57/64		451H-.890	4C21H-.890	4C11H-.890			
	23.00	0.9055	–		451H-23	4C21H-23	4C11H-23			
	23.02	0.9063	29/32		451H-0029	4C21H-0029	4C11H-0029			
	23.42	0.9219	59/64		451H-.921	4C21H-.921	4C11H-.921			
	23.50	0.9252	–		451H-23.5	4C21H-23.5	4C11H-23.5			
	23.81	0.9375	15/16		451H-0030	4C21H-0030	4C11H-0030			
	24.00	0.9449	–		451H-24	4C21H-24	4C11H-24			

POZNÁMKA: Destičky série 1.5 lze použít jak v držácích série 1, tak 1.5, ale destičky série 1 pouze v držácích série 1. Bližší informace na str. A30: 7

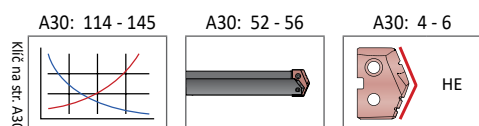

Položky s povlaky neuvedenými výše jsou dodávány jako nestandardní.



Destičky jsou dodávány po dvou kusech

TiN = 131T-XXXX	TiAlN = 131A-XXXX
TiCN = 131N-XXXX	AM200® = 131H-XXXX

Břítové destičky T-A® Original

Série 1 | HSS | Rozsah průměrů: 17,53 mm - 24,38 mm (0.690" - 0.960")

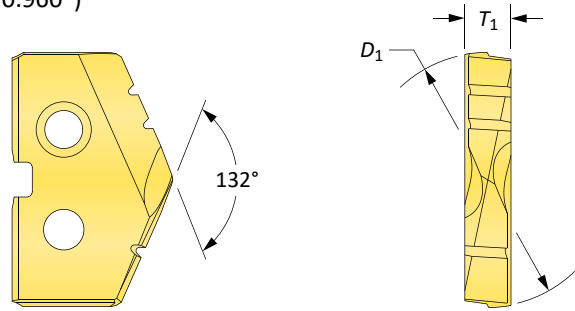
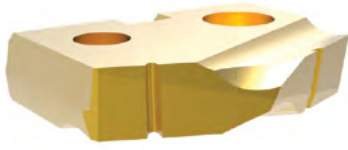

Destičky HSS – Premium Cobalt

Série	Destička				Kód		
	D_1 mm	D_1 inch	Palců (zlomkem)	T_1 mm	TiN	TiAlN	TiCN
1	17.86	0.7031	45/64	4.00	181T-.703	181A-.703	181N-.703
	18.00	0.7087	-		181T-18	181A-18	181N-18
	18.26	0.7188	23/32		181T-0023	181A-0023	181N-0023
	18.50	0.7283	-		181T-18.5	181A-18.5	181N-18.5
	18.65	0.7344	47/64		181T-.734	181A-.734	181N-.734
	19.00	0.7480	-		181T-19	181A-19	181N-19
	19.05	0.7500	3/4		181T-0024	181A-0024	181N-0024
	19.45	0.7656	49/64		181T-.765	181A-.765	181N-.765
	19.50	0.7677	-		181T-19.5	181A-19.5	181N-19.5
	19.84	0.7813	25/32		181T-0025	181A-0025	181N-0025
	20.00	0.7874	-		181T-20	181A-20	181N-20
	20.24	0.7969	51/64		181T-.796	181A-.796	181N-.796
	20.34	0.8010	-		181T-.801	181A-.801	181N-.801
	20.50	0.8071	-		181T-20.5	181A-20.5	181N-20.5
	20.64	0.8125	13/16		181T-0026	181A-0026	181N-0026
	21.00	0.8268	-		181T-21	181A-21	181N-21
	21.43	0.8438	27/32		181T-0027	181A-0027	181N-0027
21.50	0.8465	-	181T-21.5	181A-21.5	181N-21.5		
1.5	21.83	0.8594	55/64	4.00	181T-.859	181A-.859	181N-.859
	22.00	0.8661	-		181T-22	181A-22	181N-22
	22.23	0.8750	7/8		181T-0028	181A-0028	181N-0028
	22.50	0.8858	-		181T-22.5	181A-22.5	181N-22.5
	20.62	0.8906	57/64		181T-.890	181A-.890	181N-.890
	23.00	0.9055	-		181T-23	181A-23	181N-23
	23.02	0.9063	29/32		181T-0029	181A-0029	181N-0029
	23.42	0.9219	59/64		181T-.921	181A-.921	181N-.921
	23.50	0.9252	-		181T-23.5	181A-23.5	181N-23.5
	23.81	0.9375	15/16		181T-0030	181A-0030	181N-0030
	24.00	0.9449	-		181T-24	181A-24	181N-24

POZNÁMKA: Destičky série 1.5 lze použít jak v držácích série 1, tak 1.5, ale destičky série 1 pouze v držácích série 1. Bližší informace na str. A30: 7

A30: 114 - 145 A30: 52 - 56 A30: 4 - 6

HI, HR, CR, TC, SK, NP, IN, RN, CN, AN, BR, CI, CP, NC, WC

Položky s povlaky neuvedenými výše jsou dodávány jako nestandardní.

Destičky jsou dodávány po dvou kusech

TiN = 131T-XXXX	TiAlN = 131A-XXXX
TiCN = 131N-XXXX	AM200° = 131H-XXXX

Břítové destičky T-A® Original

Série 1 | HSS | Rozsah průměrů: 17,53 mm - 24,38 mm (0.690" - 0.960")

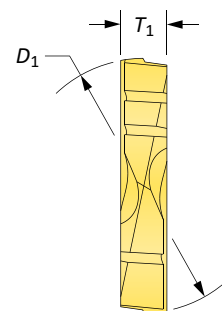
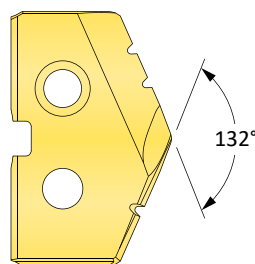

Destičky HSS – Super Cobalt

Série	Destička			T ₁ mm	Kód		
	D ₁ mm	D ₁ inch	Palců (zlomkem)		TiN	TiAlN	TiCN
1	17.86	0.7031	45/64	4.00	151T-.703	151A-.703	151N-.703
	18.00	0.7087	–		151T-18	151A-18	151N-18
	18.26	0.7188	23/32		151T-0023	151A-0023	151N-0023
	18.50	0.7283	–		151T-18.5	151A-18.5	151N-18.5
	18.65	0.7344	47/64		151T-.734	151A-.734	151N-.734
	19.00	0.7480	–		151T-19	151A-19	151N-19
	19.05	0.7500	3/4		151T-0024	151A-0024	151N-0024
	19.45	0.7656	49/64		151T-.765	151A-.765	151N-.765
	19.50	0.7677	–		151T-19.5	151A-19.5	151N-19.5
	19.84	0.7813	25/32		151T-0025	151A-0025	151N-0025
	20.00	0.7874	–		151T-20	151A-20	151N-20
	20.24	0.7969	51/64		151T-.796	151A-.796	151N-.796
	20.34	0.8010	–		151T-.801	151A-.801	151N-.801
	20.50	0.8071	–		151T-20.5	151A-20.5	151N-20.5
	20.64	0.8125	13/16		151T-0026	151A-0026	151N-0026
	21.00	0.8268	–		151T-21	151A-21	151N-21
21.43	0.8438	27/32	151T-0027	151A-0027	151N-0027		
21.50	0.8465	–	151T-21.5	151A-21.5	151N-21.5		
1.5	21.83	0.8594	55/64	4.0	151T-.859	151A-.859	151N-.859
	22.00	0.8661	–		151T-22	151A-22	151N-22
	22.23	0.8750	7/8		151T-0028	151A-0028	151N-0028
	22.50	0.8858	–		151T-22.5	151A-22.5	151N-22.5
	20.62	0.8906	57/64		151T-.890	151A-.890	151N-.890
	23.00	0.9055	–		151T-23	151A-23	151N-23
	23.02	0.9063	29/32		151T-0029	151A-0029	151N-0029
	23.42	0.9219	59/64		151T-.921	151A-.921	151N-.921
	23.50	0.9252	–		151T-23.5	151A-23.5	151N-23.5
	23.81	0.9375	15/16		151T-0030	151A-0030	151N-0030
	24.00	0.9449	–		151T-24	151A-24	151N-24

POZNÁMKA: Destičky série 1.5 lze použít jak v držácích série 1, tak 1.5, ale destičky série 1 pouze v držácích série 1. Bližší informace na str. A30: 7

A30: 114 - 145

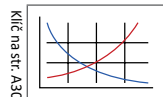

Klíč na str. A30: 1

A30: 52 - 56

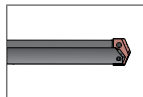

A30: 4 - 6



HI, HR, CR, TC, SK,
NP, IN, RN, CN, AN,
BR, CI, CP, NC, WC

Položky s povlaky
neuvezenými výše jsou
dodávány jako nestandardní.



Destičky jsou dodávány po dvou kusech

TiN = 131T-XXXX	TiAlN = 131A-XXXX
TiCN = 131N-XXXX	AM200® = 131H-XXXX

Břítové destičky T-A® Original

Série 1 | HSS | Rozsah průměrů: 17,53 mm - 24,38 mm (0.690" - 0.960")

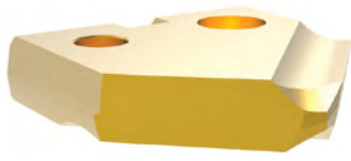

90° Spot & Chamfer

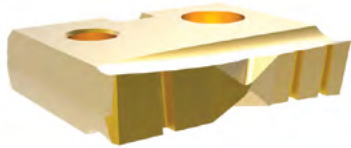

Rovné dno (FB)

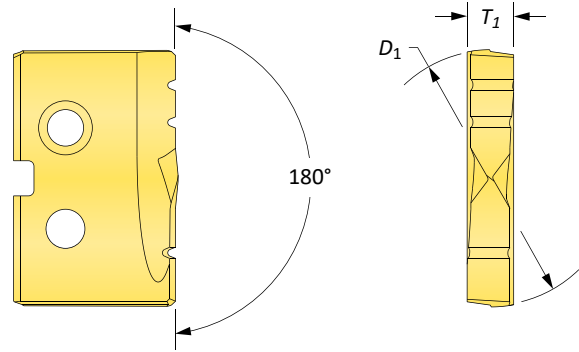
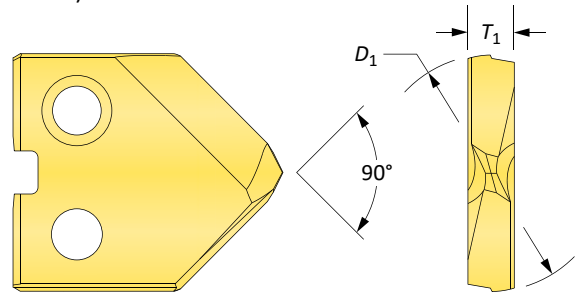

Destičky HSS – Super Cobalt

Série	Destička			T ₁ mm	Kód 90° Spot & Chamfer			Kód Flat Bottom
	D ₁ mm	D ₁ inch	Palců (zlomkem)		TiN	TiAlN	TiCN	TiN
1	17.86	0.7031	45/64	4.00	151T-.703-SP	151A-.703-SP	151N-.703-SP	151T-.703-FB
	18.00	0.7087	-		151T-18-SP	151A-18-SP	151N-18-SP	151T-18-FB
	18.26	0.7188	23/32		151T-0023-SP	151A-0023-SP	151N-0023-SP	151T-0023-FB
	18.50	0.7283	-		151T-18.5-SP	151A-18.5-SP	151N-18.5-SP	151T-18.5-FB
	18.65	0.7344	47/64		151T-.734-SP	151A-.734-SP	151N-.734-SP	151T-.734-FB
	19.00	0.7480	-		151T-19-SP	151A-19-SP	151N-19-SP	151T-19-FB
	19.05	0.7500	3/4		151T-0024-SP	151A-0024-SP	151N-0024-SP	151T-0024-FB
	19.45	0.7656	49/64		151T-.765-SP	151A-.765-SP	151N-.765-SP	151T-.765-FB
	19.50	0.7677	-		151T-19.5-SP	151A-19.5-SP	151N-19.5-SP	151T-19.5-FB
	19.84	0.7813	25/32		151T-0025-SP	151A-0025-SP	151N-0025-SP	151T-0025-FB
	20.00	0.7874	-		151T-20-SP	151A-20-SP	151N-20-SP	151T-20-FB
	20.24	0.7969	51/64		151T-.796-SP	151A-.796-SP	151N-.796-SP	151T-.796-FB
	20.34	0.8010	-		151T-.801-SP	151A-.801-SP	151N-.801-SP	151T-.801-FB
	20.50	0.8071	-		151T-20.5-SP	151A-20.5-SP	151N-20.5-SP	151T-20.5-FB
	20.64	0.8125	13/16		151T-0026-SP	151A-0026-SP	151N-0026-SP	151T-0026-FB
21.00	0.8268	-	151T-21-SP	151A-21-SP	151N-21-SP	151T-21-FB		
21.43	0.8438	27/32	151T-0027-SP	151A-0027-SP	151N-0027-SP	151T-0027-FB		
21.50	0.8465	-	151T-21.5-SP	151A-21.5-SP	151N-21.5-SP	151T-21.5-FB		
1.5	21.83	0.8594	55/64	4.0	151T-.859-SP	151A-.859-SP	151N-.859-SP	151T-.859-FB
	22.00	0.8661	-		151T-22-SP	151A-22-SP	151N-22-SP	151T-22-FB
	22.23	0.8750	7/8		151T-0028-SP	151A-0028-SP	151N-0028-SP	151T-0028-FB
	22.50	0.8858	-		151T-22.5-SP	151A-22.5-SP	151N-22.5-SP	151T-22.5-FB
	20.62	0.8906	57/64		151T-.890-SP	151A-.890-SP	151N-.890-SP	151T-.890-FB
	23.00	0.9055	-		151T-23-SP	151A-23-SP	151N-23-SP	151T-23-FB
	23.02	0.9063	29/32		151T-0029-SP	151A-0029-SP	151N-0029-SP	151T-0029-FB
	23.42	0.9219	59/64		151T-.921-SP	151A-.921-SP	151N-.921-SP	151T-.921-FB
	23.50	0.9252	-		151T-23.5-SP	151A-23.5-SP	151N-23.5-SP	151T-23.5-FB
	23.81	0.9375	15/16		151T-0030-SP	151A-0030-SP	151N-0030-SP	151T-0030-FB
	24.00	0.9449	-		151T-24-SP	151A-24-SP	151N-24-SP	151T-24-FB

POZNÁMKA: Destičky série 1.5 lze použít jak v držácích série 1, tak 1.5, ale destičky série 1 pouze v držácích série 1. Bližší informace na str. A30: 7

A30: 114 - 145

A30: 52 - 56

A30: 4 - 6

SW

A30: 4 - 6

FN

Položky s povlaky neuvedenými výše jsou dodávány jako nestandardní.

Destičky jsou dodávány po dvou kusech

TiN = 131T-XXXX	TiAlN = 131A-XXXX
TiCN = 131N-XXXX	AM200® = 131H-XXXX

Břitové destičky T-A® Original



Série 1 | HSS | Rozsah průměrů: 17,53 mm - 24,38 mm (0.690" - 0.960")

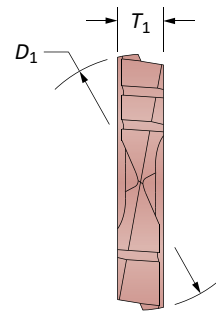
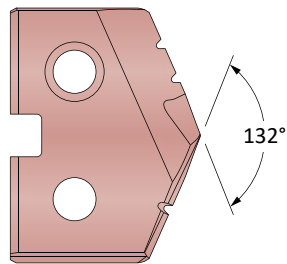

Tube Sheet - trubkovnice



Destičky HSS - Super Cobalt | HSS

Série	Destička				Kód	
	D_1 mm	D_1 inch	Palců (zlomkem)	T_1 mm	 Super Cobalt	 HSS
1	19.25	0.7580	-	4.00	151H-.7580-IN	131H-.7580-IN
	19.45	0.7656	49/64		151H-.765-IN	131H-.765-IN
	19.85	0.7813	25/32		151H-0025-IN	131H-0025-IN

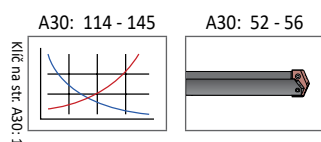

Položky s povlaky
neuvedenými výše jsou
dodávány jako nestandardní.



Destičky jsou dodávány po dvou kusech

TiN = 131T-XXXX	TiAlN = 131A-XXXX
TiCN = 131N-XXXX	AM200® = 131H-XXXX

Břítové destičky T-A® Original

Série 1 | HSS | Rozsah průměrů: 17,53 mm - 24,38 mm (0.690" - 0.960")

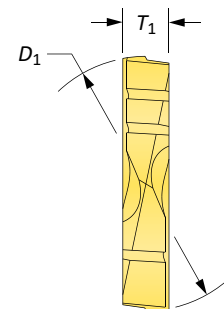
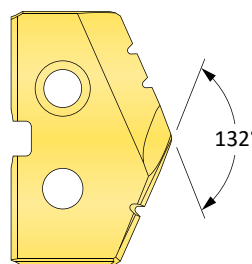

Destičky HSS – HSS

Série	Destička			T ₁ mm	Kód		
	D ₁ mm	D ₁ inch	Palců (zlomkem)		TiN	TiAlN	TiCN
1	17.86	0.7031	45/64	4.00	131T-.703	131A-.703	131N-.703
	18.00	0.7087	-		131T-18	131A-18	131N-18
	18.26	0.7188	23/32		131T-0023	131A-0023	131N-0023
	18.50	0.7283	-		131T-18.5	131A-18.5	131N-18.5
	18.65	0.7344	47/64		131T-.734	131A-.734	131N-.734
	19.00	0.7480	-		131T-19	131A-19	131N-19
	19.05	0.7500	3/4		131T-0024	131A-0024	131N-0024
	19.45	0.7656	49/64		131T-.765	131A-.765	131N-.765
	19.50	0.7677	-		131T-19.5	131A-19.5	131N-19.5
	19.84	0.7813	25/32		131T-0025	131A-0025	131N-0025
	20.00	0.7874	-		131T-20	131A-20	131N-20
	20.24	0.7969	51/64		131T-.796	131A-.796	131N-.796
	20.34	0.8010	-		131T-.801	131A-.801	131N-.801
	20.50	0.8071	-		131T-20.5	131A-20.5	131N-20.5
	20.64	0.8125	13/16		131T-0026	131A-0026	131N-0026
	21.00	0.8268	-		131T-21	131A-21	131N-21
21.43	0.8438	27/32	131T-0027	131A-0027	131N-0027		
21.50	0.8465	-	131T-21.5	131A-21.5	131N-21.5		
1.5	21.83	0.8594	55/64	4.00	131T-.859	131A-.859	131N-.859
	22.00	0.8661	-		131T-22	131A-22	131N-22
	22.23	0.8750	7/8		131T-0028	131A-0028	131N-0028
	22.50	0.8858	-		131T-22.5	131A-22.5	131N-22.5
	20.62	0.8906	57/64		131T-.890	131A-.890	131N-.890
	23.00	0.9055	-		131T-23	131A-23	131N-23
	23.02	0.9063	29/32		131T-0029	131A-0029	131N-0029
	23.42	0.9219	59/64		131T-.921	131A-.921	131N-.921
	23.50	0.9252	-		131T-23.5	131A-23.5	131N-23.5
	23.81	0.9375	15/16		131T-0030	131A-0030	131N-0030
	24.00	0.9449	-		131T-24	131A-24	131N-24

POZNÁMKA: Destičky série 1.5 lze použít jak v držácích série 1, tak 1.5, ale destičky série 1 pouze v držácích série 1. Bližší informace na str. A30: 7

A30: 114 - 145

 Klíč na str. A30: 1

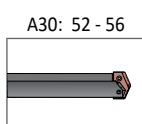

A30: 4 - 6

 HI, HR, CR, TC, SK,
 NP, IN, RN, CN, AN,
 BR, CI, CP, NC, WC

Položky s povlaky neuvedenými výše jsou dodávány jako nestandardní.

Destičky jsou dodávány po dvou kusech

TiN = 131T-XXXX	TiAlN = 131A-XXXX
TiCN = 131N-XXXX	AM200® = 131H-XXXX

Břítové destičky T-A® Original

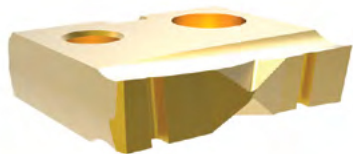
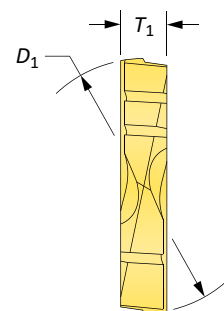
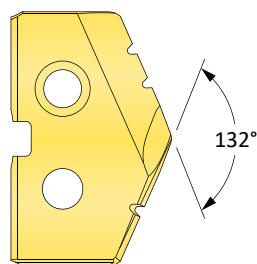
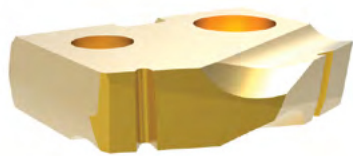

Série 1 | Karbidové | Rozsah průměrů: 17,53 mm - 24,38 mm (0.690" - 0.960")

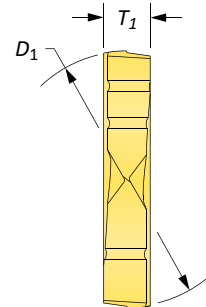
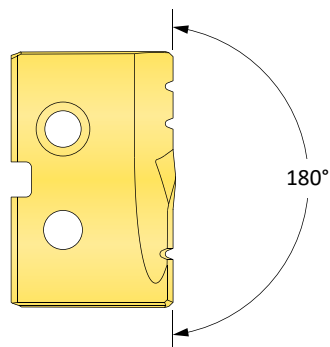

Rovné dno (FB)





Karbidové destičky – K20 (C2)

Série	Destička			T ₁ mm	Kód		Kód Flat Bottom
	D ₁ mm	D ₁ inch	Palců (zlomkem)		 TiN	 TiAlN	 TiN
1	17.86	0.7031	45/64	4.00	1C21T-.703	1C21A-.703	1C21T-.703-FB
	18.00	0.7087	–		1C21T-18	1C21A-18	1C21T-18-FB
	18.26	0.7188	23/32		1C21T-0023	1C21A-0023	1C21T-0023-FB
	18.50	0.7283	–		1C21T-18.5	1C21A-18.5	1C21T-18.5-FB
	18.65	0.7344	47/64		1C21T-.734	1C21A-.734	1C21T-.734-FB
	19.00	0.7480	–		1C21T-19	1C21A-19	1C21T-19-FB
	19.05	0.7500	3/4		1C21T-0024	1C21A-0024	1C21T-0024-FB
	19.45	0.7656	49/64		1C21T-.765	1C21A-.765	1C21T-.765-FB
	19.50	0.7677	–		1C21T-19.5	1C21A-19.5	1C21T-19.5-FB
	19.84	0.7813	25/32		1C21T-0025	1C21A-0025	1C21T-0025-FB
	20.00	0.7874	–		1C21T-20	1C21A-20	1C21T-20-FB
	20.24	0.7969	51/64		1C21T-.796	1C21A-.796	1C21T-.796-FB
	20.34	0.8010	–		1C21T-.801	1C21A-.801	1C21T-.801-FB
	20.50	0.8071	–		1C21T-20.5	1C21A-20.5	1C21T-20.5-FB
	20.64	0.8125	13/16		1C21T-0026	1C21A-0026	1C21T-0026-FB
	21.00	0.8268	–		1C21T-21	1C21A-21	1C21T-21-FB
21.43	0.8438	27/32	1C21T-0027	1C21A-0027	1C21T-0027-FB		
21.50	0.8465	–	1C21T-21.5	1C21A-21.5	1C21T-21.5-FB		
1.5	21.83	0.8594	55/64	4.00	1C21T-.859	1C21A-.859	1C21T-.859-FB
	22.00	0.8661	–		1C21T-22	1C21A-22	1C21T-22-FB
	22.23	0.8750	7/8		1C21T-0028	1C21A-0028	1C21T-0028-FB
	22.50	0.8858	–		1C21T-22.5	1C21A-22.5	1C21T-22.5-FB
	20.62	0.8906	57/64		1C21T-.890	1C21A-.890	1C21T-.890-FB
	23.00	0.9055	–		1C21T-23	1C21A-23	1C21T-23-FB
	23.02	0.9063	29/32		1C21T-0029	1C21A-0029	1C21T-0029-FB
	23.42	0.9219	59/64		1C21T-.921	1C21A-.921	1C21T-.921-FB
	23.50	0.9252	–		1C21T-23.5	1C21A-23.5	1C21T-23.5-FB
	23.81	0.9375	15/16		1C21T-0030	1C21A-0030	1C21T-0030-FB
	24.00	0.9449	–		1C21T-24	1C21A-24	1C21T-24-FB

POZNÁMKA: Destičky série 1.5 lze použít jak v držácích série 1, tak 1.5, ale destičky série 1 pouze v držácích série 1. Blíže informace na str. A30: 7

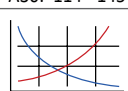
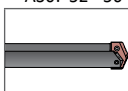
Destičky jsou dodávány po dvou kusech

A30: 114 - 145  A30: 52 - 56  A30: 4 - 6  HI, HR, CR, TC, SK, NP, IN, RN, CN, AN, BR, CI, CP, NC, WC A30: 4 - 6  FN

Položky s povlaky neuvedenými výše jsou dodávány jako nestandardní.

TiN = 131T-XXXX	TiAlN = 131A-XXXX
TiCN = 131N-XXXX	AM200® = 131H-XXXX





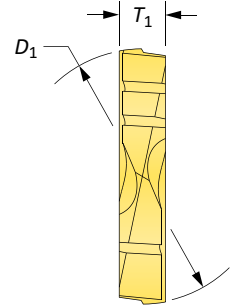
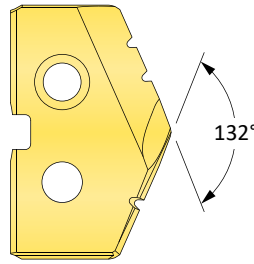
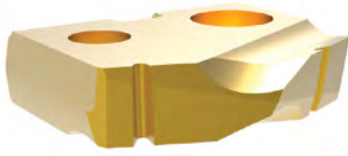

Břítové destičky T-A® Original

Série 1 | Karbidové | Rozsah průměrů: 17,53 mm - 24,38 mm (0.690" - 0.960")



Karbidové destičky - P35 (C5) | K10 (C3) | N2

Série	Destička				Kód C5		Kód C3	Kód N2
	D ₁ mm	D ₁ inch	Palců (zlomkem)	T ₁ mm	 TiN	 TiAlN	 TiAlN (Cast Iron)	 Diamond Film
1	17.86	0.7031	45/64	4.00	1C51T-.703	1C51A-.703	1C31A-.703-CI	1N21D-.703
	18.00	0.7087	-		1C51T-18	1C51A-18	1C31A-18-CI	1N21D-18
	18.26	0.7188	23/32		1C51T-0023	1C51A-0023	1C31A-0023-CI	1N21D-0023
	18.50	0.7283	-		1C51T-18.5	1C51A-18.5	1C31A-18.5-CI	1N21D-18.5
	18.65	0.7344	47/64		1C51T-.734	1C51A-.734	1C31A-.734-CI	1N21D-.734
	19.00	0.7480	-		1C51T-19	1C51A-19	1C31A-19-CI	1N21D-19
	19.05	0.7500	3/4		1C51T-0024	1C51A-0024	1C31A-0024-CI	1N21D-0024
	19.45	0.7656	49/64		1C51T-.765	1C51A-.765	1C31A-.765-CI	1N21D-.765
	19.50	0.7677	-		1C51T-19.5	1C51A-19.5	1C31A-19.5-CI	1N21D-19.5
	19.84	0.7813	25/32		1C51T-0025	1C51A-0025	1C31A-0025-CI	1N21D-0025
	20.00	0.7874	-		1C51T-20	1C51A-20	1C31A-20-CI	1N21D-20
	20.24	0.7969	51/64		1C51T-.796	1C51A-.796	1C31A-.796-CI	1N21D-.796
	20.34	0.8010	-		1C51T-.801	1C51A-.801	1C31A-.801-CI	1N21D-.801
	20.50	0.8071	-		1C51T-20.5	1C51A-20.5	1C31A-20.5-CI	1N21D-20.5
	20.64	0.8125	13/16		1C51T-0026	1C51A-0026	1C31A-0026-CI	1N21D-0026
	21.00	0.8268	-		1C51T-21	1C51A-21	1C31A-21-CI	1N21D-21
21.43	0.8438	27/32	1C51T-0027	1C51A-0027	1C31A-0027-CI	1N21D-0027		
21.50	0.8465	-	1C51T-21.5	1C51A-21.5	1C31A-21.5-CI	1N21D-21.5		
1.5	21.83	0.8594	55/64	4.00	1C51T-.859	1C51A-.859	1C31A-.859-CI	1N21D-.859
	22.00	0.8661	-		1C51T-22	1C51A-22	1C31A-22-CI	1N21D-22
	22.23	0.8750	7/8		1C51T-0028	1C51A-0028	1C31A-0028-CI	1N21D-0028
	22.50	0.8858	-		1C51T-22.5	1C51A-22.5	1C31A-22.5-CI	1N21D-22.5
	20.62	0.8906	57/64		1C51T-.890	1C51A-.890	1C31A-.890-CI	1N21D-.890
	23.00	0.9055	-		1C51T-23	1C51A-23	1C31A-23-CI	1N21D-23
	23.02	0.9063	29/32		1C51T-0029	1C51A-0029	1C31A-0029-CI	1N21D-0029
	23.42	0.9219	59/64		1C51T-.921	1C51A-.921	1C31A-.921-CI	1N21D-.921
	23.50	0.9252	-		1C51T-23.5	1C51A-23.5	1C31A-23.5-CI	1N21D-23.5
	23.81	0.9375	15/16		1C51T-0030	1C51A-0030	1C31A-0030-CI	1N21D-0030
	24.00	0.9449	-		1C51T-24	1C51A-24	1C31A-24-CI	1N21D-24

POZNÁMKA: Destičky série 1.5 lze použít jak v držácích série 1, tak 1.5, ale destičky série 1 pouze v držácích série 1. Bližší informace na str. A30: 7

Destičky jsou dodávány po dvou kusech

TiN = 131T-XXXX	TiAlN = 131A-XXXX
TiCN = 131N-XXXX	AM200® = 131H-XXXX

Položky s povlaky neuvedenými výše jsou dodávány jako nestandardní.



A30: 114 - 145

A30: 52 - 56

A30: 4 - 6

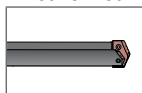
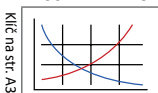

HI, HR, CR, TC, SK,
NP, IN, RN, CN, AN,
BR, CI, CP, NC, WC

Klíč na str. A30: 1